

Ø 140 MM, SINGLE INLET

EC BLOWER



Features

- **Materials Impeller:** galvanized steel
- **Materials Housing:** Die-cast aluminium
- **Direction of rotation:** clockwise, seen on rotor
- **Type of protection:** IP55
- **Insulation class:** B
- **Mode of operation:** continuous operation (S1)
- **Bearing:** ball bearings
- **Motor protection:** self-resetting TOP wired internally



Technical data

Model	Perform. curve	Nominal voltage [VAC]	Frequency [Hz]	Speed [RPM]	Power input max [W]	Current max [A]	Sound pres. level [dB(A)]	Perm. amb. temp. [°C]	Capacitor [µF/VDB]	Electrical connection
SL-F140B-EC-12	I	230	50/60	1940	64	0.54	65	-25 ... +60	-	E

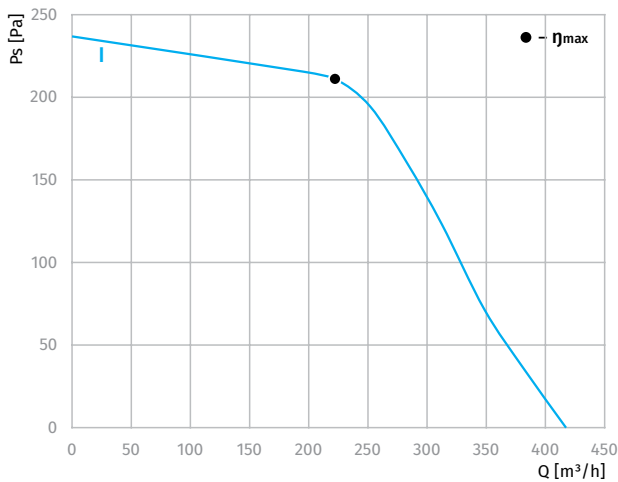

Overall Dimensions

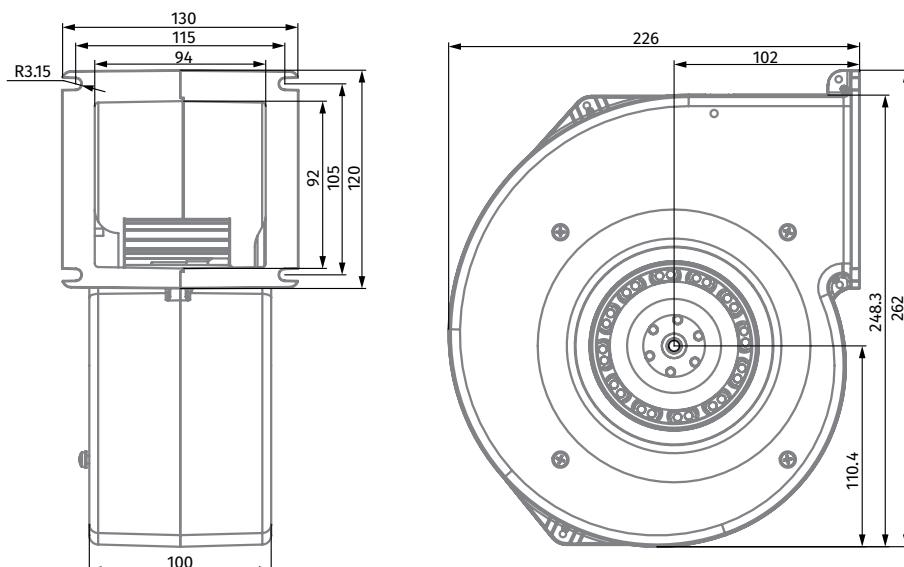

AC AXIAL FANS

BACKWARD CURVED AC CENTRIFUGAL FANS

BACKWARD CURVED EC CENTRIFUGAL FANS

FORWARD CURVED AC CENTRIFUGAL FANS

FORWARD CURVED EC CENTRIFUGAL FANS

AC BLOWERS

EC BLOWERS

AC MOTORS