

PRODUCT SPECIFICATION

TYPE	EC centrifugal fan, forward curved
MODEL	DL-F133B-EC-00

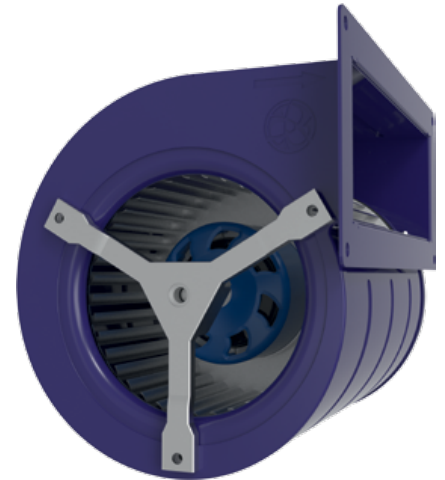

NOMINAL DATA



Phase	-	1~
Nominal Voltage	VAC	230
Frequency	Hz	50/60
Speed	RPM	2740
Power Input	W	76
Current	A	0.55
Sound Pressure Level	dBA	67
Valid For Approval/Standard		CE
Min. Ambient Temperature	°C	-25
Max. Ambient Temperature	°C	+60

TECHNICAL FEATURES

Mass	3.35 Kg
Dimensions	133 mm
Material Of Impeller	galvanized steel
Material Of Housing	Sheet steel
Number Of Blades	38
Direction Of Rotation	Clockwise, seen on rotor
Surface Of Rotor	Coated in reflex BLUE C
Type of protection	IP55
Insulation Class	B
Condensate Discharge Holes	On rotor side
Min./Max. permissible ambient motor temperature (transportable/ storage)	- 40°C ... + 80°C
Operation Mode	S1
Motor Bearing	Ball bearing
Motor Protection	Self-resetting TOP wired internally
Length Of Cable	500 mm
RoHS	All material accord with RoHS
Min./Max. Humidity	0% ... 90% RH
Motor	External rotor EC motor
Deviation Of Impeller In Axial Direction	≤0.5mm
Deviation Of Impeller In Radial Direction	≤0.5mm

PERFORMANCE CURVES

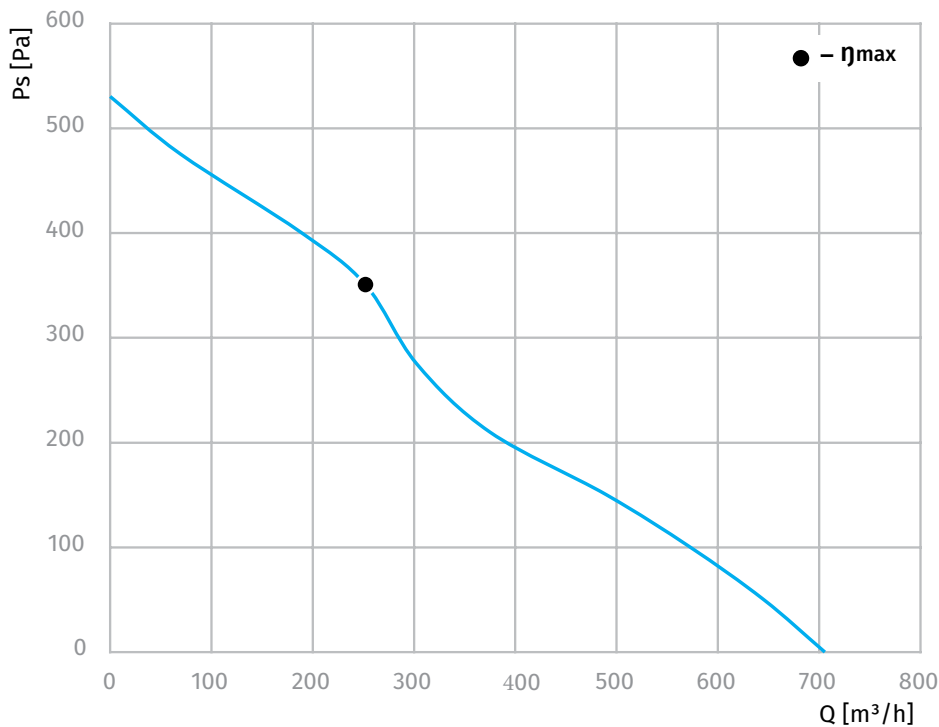

DATA ACCORDING TO ErP DIRECTIVE

Not subject to ErP regulations ($P_1 < 125W$).

ELECTRICAL CONNECTION DIAGRAMM

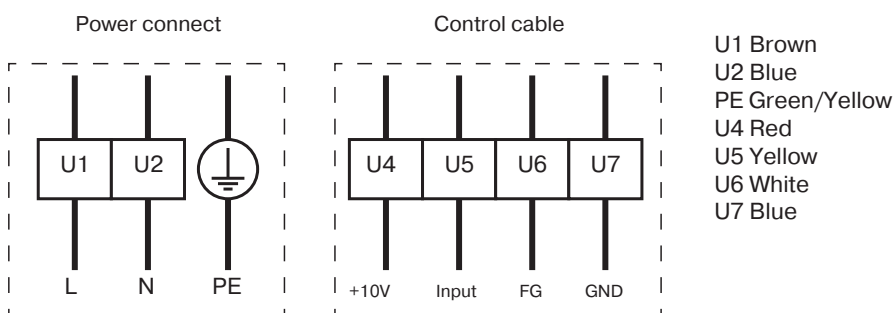

DIMENSIONS DRAWING

