

Ø 250 MM, BACKWARD CURVED

EC CENTRIFUGAL FAN



Features

- Speed control: 0 ~ 10 V DC/PWM
- Impeller material: PA plastic + 30 % glass fiber
- Direction of rotation: clockwise, seen on rotor
- Type of protection: IP55
- Insulation class: B
- Mode of operation: continuous operation (S1)
- Bearing: ball bearings
- Motor protection: self-resetting TOP wired internally



Technical data

Model	Perform. curve	Nominal voltage [VAC]	Frequency [Hz]	Speed [RPM]	Power input max [W]	Current max [A]	Sound pres. level [dBA]	Perm. amb. temp. [°C]	Capacitor [µF/VDB]	Electrical connection
BL-B250B-EC-01	I	230	50/60	2570	169	1.27	73	-25 ... +60	-	E

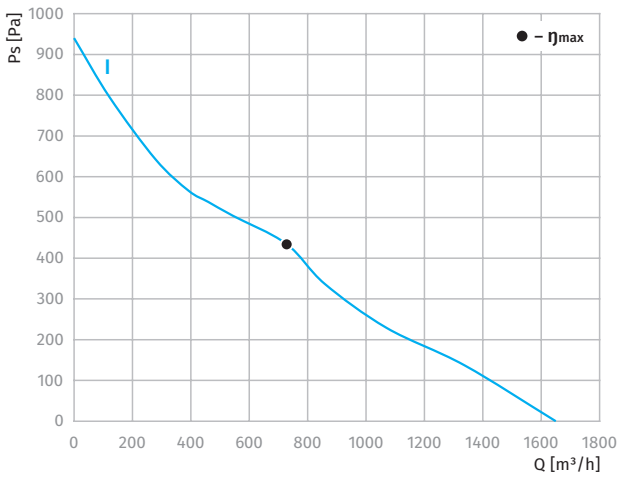

Overall dimensions

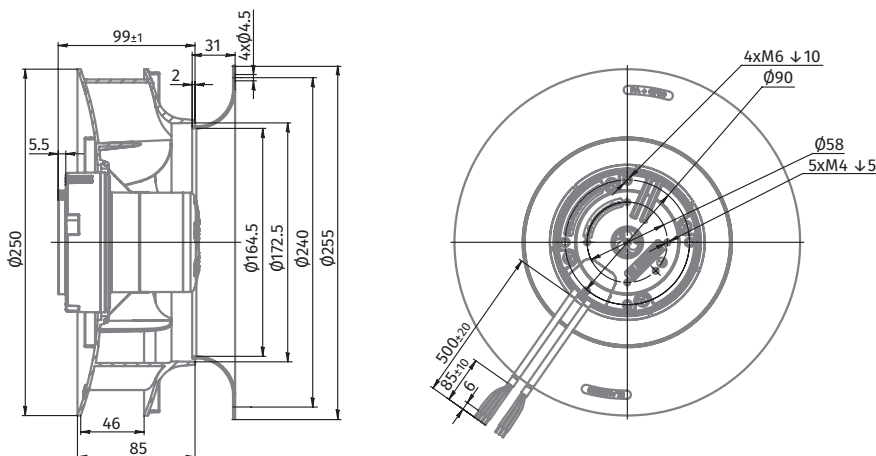

BACKWARD CURVED
AC CENTRIFUGAL FANS

BACKWARD CURVED
EC CENTRIFUGAL FANS

FORWARD CURVED
AC CENTRIFUGAL FANS

FORWARD CURVED
EC CENTRIFUGAL FANS

FORWARD CURVED
AC BLOWERS

FORWARD CURVED
EC BLOWERS

BACKWARD CURVED
EC BLOWERS